

Sohlbankanschlüsse

Sill connections

für **TROCAL**

for TROCAL

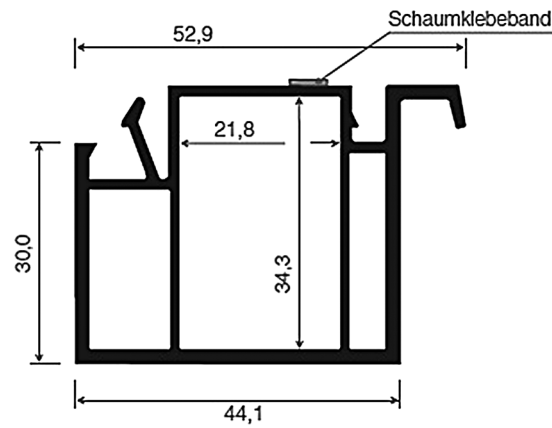

612

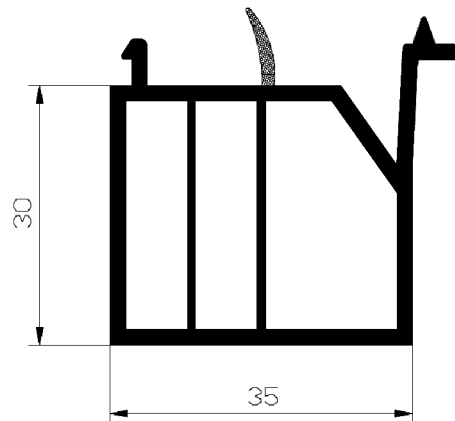





630

Sohlbankanschlüsse

Sill connections

für TROCAL
for TROCAL

| Art.-Nr. Cat.-No. | Sohlbankanschluss Sill connections | Packung / lfm. Package / mtr. | Ausführung Execution | Lieferung Delivery |
|----------------------|---------------------------------------|----------------------------------|---|---|
| 612 | Trocal 30 mm / FV | 65 |  |  |
| 630 | Trocal 30 mm / 88+ | 60 |  |  |

- Art.-Nr. 612: 76er und 88er Bautiefe
- FV – flächenversetzt einsetzbar

- Cat.-No. 612: 76 mm and 88 mm construction depth
- FV – connection offset

Sohlbankanschlüsse und

Sill connections and

Transportschutz für Kömmerling

transport protection for Kömmerling

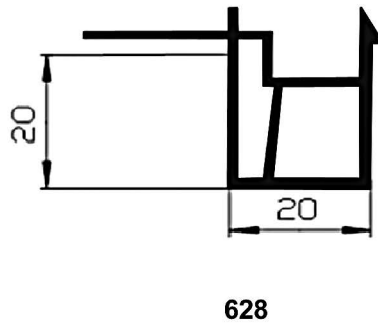
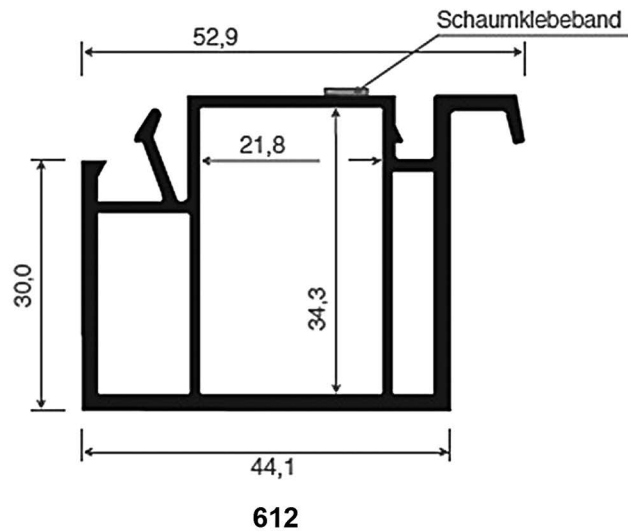

Sohlbankanschlüsse und Sill connections and Transportschutz für Kömmerling transport protection for Kömmerling

| Art.-Nr. Cat.-No. | Sohlbankanschluss Sill connections | Packung / lfm. Package / mtr. | Ausführung Execution | Lieferung Delivery |
|----------------------|---------------------------------------|----------------------------------|-------------------------|-----------------------|
| 612 | Köm 30 mm / FV | 65 | ● | ☎ |
| 628 | Futur 20 mm / FV / 70er | 60 | ● | ☎ |

- Art.1-Nr. 612: 76er und 88er Bautiefe
- FV – flächenversetzt einsetzbar
- FB – flächenversetzt einsetzbar

- Cat.-No. 612: 76 mm and 88 mm construction depth
- FV – connection offset
- FB – connection flush

Sohlbankanschlüsse und Sill connections and Transportschutz für Rehau transport protection for Rehau

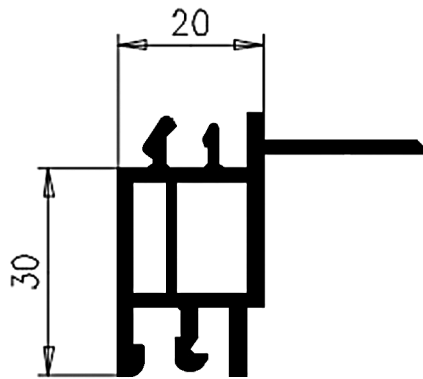

470

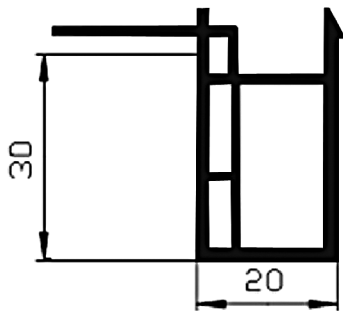

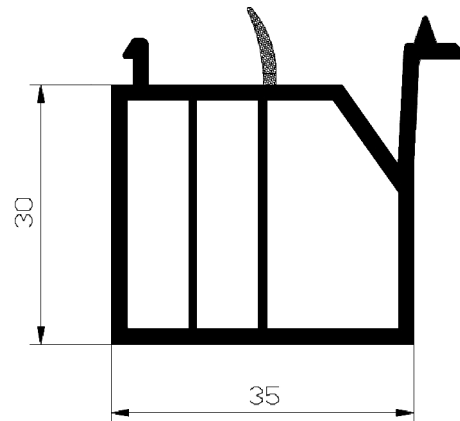

635



631

Sohlbankanschlüsse und Sill connections and Transportschutz für Rehau transport protection for Rehau

| Art.-Nr. Cat.-No. | Sohlbankanschluss Sill connections | Packung / lfm. Package / mtr. | Ausführung Execution | Lieferung Delivery |
|----------------------|---------------------------------------|----------------------------------|-------------------------|---|
| 470 | 30 mm FB + FV | 60 | ● |  |
| 635 | 30 mm FV | 60 | ● |  |
| 631 | 30 mm FV | 60 | ● |  |

- 70er und 80er Bautiefe
- FV – flächenversetzt einsetzbar
- FB – flächenversetzt einsetzbar
- 70 mm and 80 mm construction depth
- FV – connection offset
- FB – connection flush

Sohlbankanschlüsse und Sill connections and Transportschutz für Veka transport protection for Veka

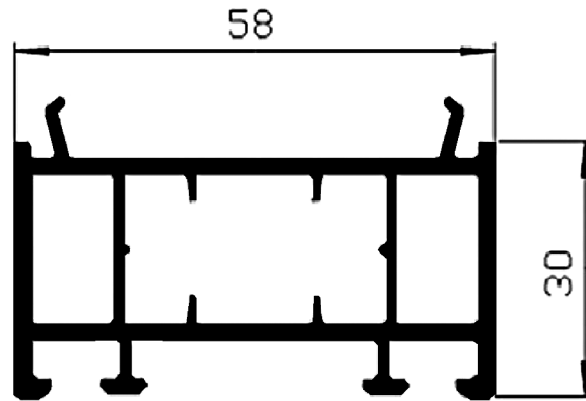

671

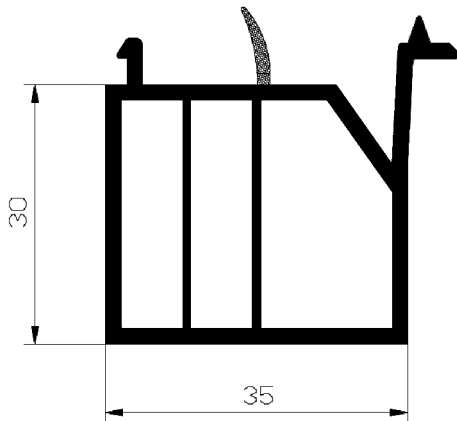

687

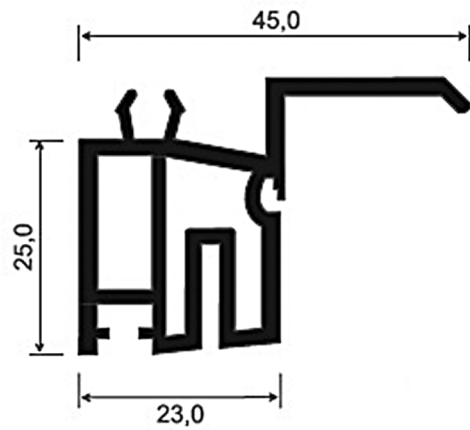

613

Sohlbankanschlüsse und Sill connections and Transportschutz für Veka transport protection for Veka

| Art.-Nr. Cat.-No. | Sohlbankanschluss Sill connections | Packung / lfm. Package / mtr. | Ausführung Execution | Lieferung Delivery |
|----------------------|---------------------------------------|----------------------------------|-------------------------|-----------------------|
| 613 | 25 mm, FV | 65 | ● | ☎ |
| 671 | 30 mm, A, FB | 60 | ○ | ☎ |
| 687 | 30 mm, C, FV | 60 | ● | 🚚 |

- Bautiefen: A = 60 mm C = 80 mm
- FV – flächenversetzt einsetzbar
- FB – flächenversetzt einsetzbar
- construction depth: A = 60 mm C = 80 mm
- FV – connection offset
- FB – connection flush

Sohlbankanschlüsse

Sill connections

Veka

Veka

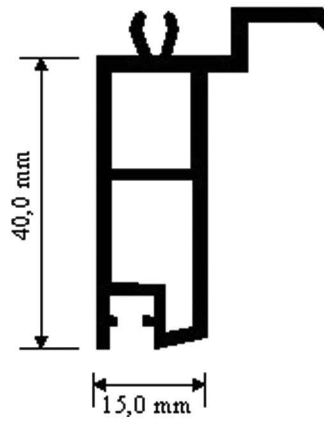

652

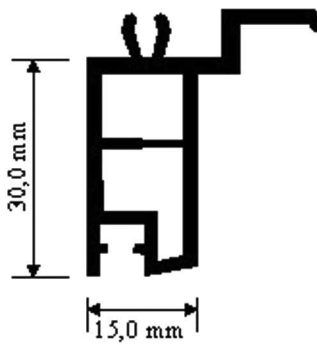

651

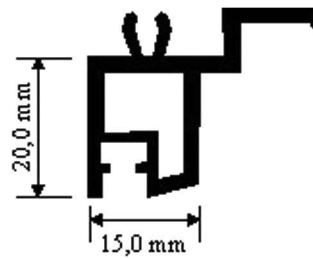



650

Sohlbankanschlüsse

Sill connections

Veka

Veka

| Art.-Nr. Cat.-No. | Sohlbankanschluss Sill connections | Packung / lfm. Package / mtr. | Ausführung Execution | Lieferung Delivery |
|----------------------|---------------------------------------|----------------------------------|-------------------------|---|
| 650 | 20 mm, FB | 65 | ○ |  |
| 651 | 30 mm, FB | 65 | ○ |  |
| 652 | 40 mm, FB | 65 | ○ |  |

- Lieferlänge 6,5 m
- FB – flächenversetzt einsetzbar
- innen oder außen bündig

- delivered length 6500 mm
- FB – connection flush
- flush inside or outside

Sohlbankanschlüsse und

Sill connections and

Transportschutz für Schüco

transport protection for Schüco

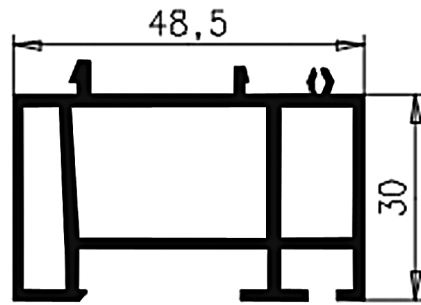

682

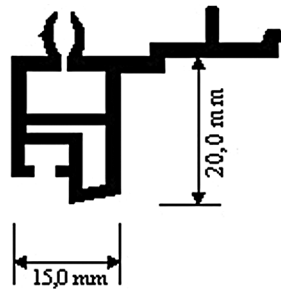

640

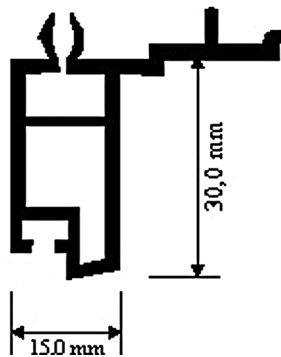



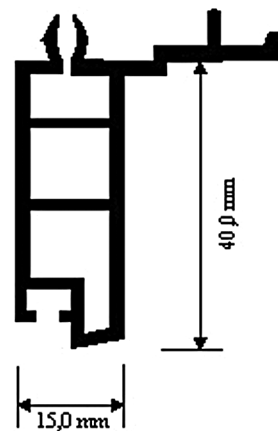







641



642

Sohlbankanschlüsse und Sill connections and Transportschutz für Schüco transport protection for Schüco

| Art.-Nr. Cat.-No. | Sohlbankanschluss Sill connections | Packung / lfm. Package / mtr. | Ausführung Execution | Lieferung Delivery |
|----------------------|---------------------------------------|----------------------------------|---|---|
| 682 | 30 mm, A, FB + FV | 36 |  |  |
| 682 | 30 mm, A, FB + FV | 36 |  |  |
| 640 | 20 mm, FB | 60 |  |  |
| 641 | 30 mm, FB | 60 |  |  |
| 642 | 40 mm, FB | 60 |  |  |

- A = für CT70 einsetzbar
- FV – flächenversetzt einsetzbar
- FB – flächenversetzt einsetzbar

- A = can be used for CT70
- FV – connection offset
- FB – connection flush

Sohlbankanschlüsse

Sill connections

für Gealan

for Gealan

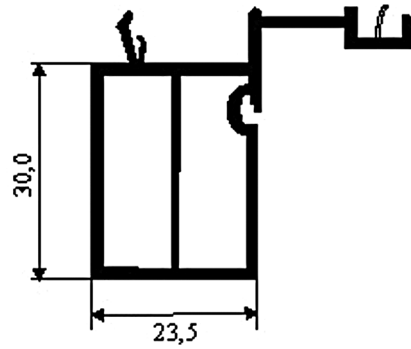

693/7

Sohlbankanschlüsse

Sill connections

für Gealan

for Gealan

| Art.-Nr. Cat.-No. | Sohlbankanschluss Sill connections | Packung / lfm. Package / mtr. | Ausführung Execution | Lieferung Delivery |
|----------------------|---------------------------------------|----------------------------------|-------------------------|-----------------------|
| 693/7 | 30 mm, FV | 60 | ● | ☎ |
| 693 | 30 mm, FV, FB | 60 | ○ | ☎ |

- FV – flächenversetzt einsetzbar
- FB – flächenversetzt einsetzbar

- FV – connection offset
- FB – connection flush

Bodeneinstandsprofil

Bottom insert profile

und Universal zum Verschrauben

and universal for screw fastening

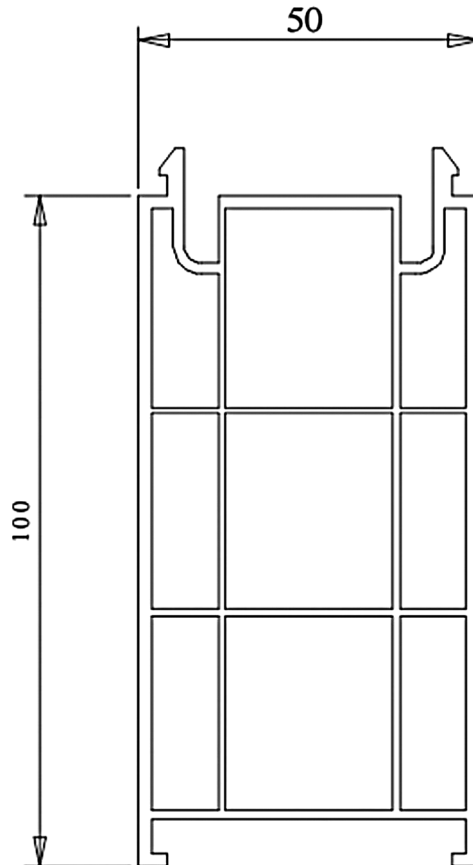



710

Bodeneinstandsprofil

Bottom insert profile

und Universal zum Verschrauben

and universal for screw fastening

| Art.-Nr. Cat.-No. | Bodeneinstandsprofil Bottom insert profile | Packung / lfm. Package / mtr. | Ausführung Execution | Lieferung Delivery |
|----------------------|---|----------------------------------|---|---|
| 710 | 100 mm | 12 |  |  |

- FV – flächenversetzt einsetzbar
- universal zum Schrauben

- FV – connection offset
- universal for screwing

Bodeneinstandsprofil



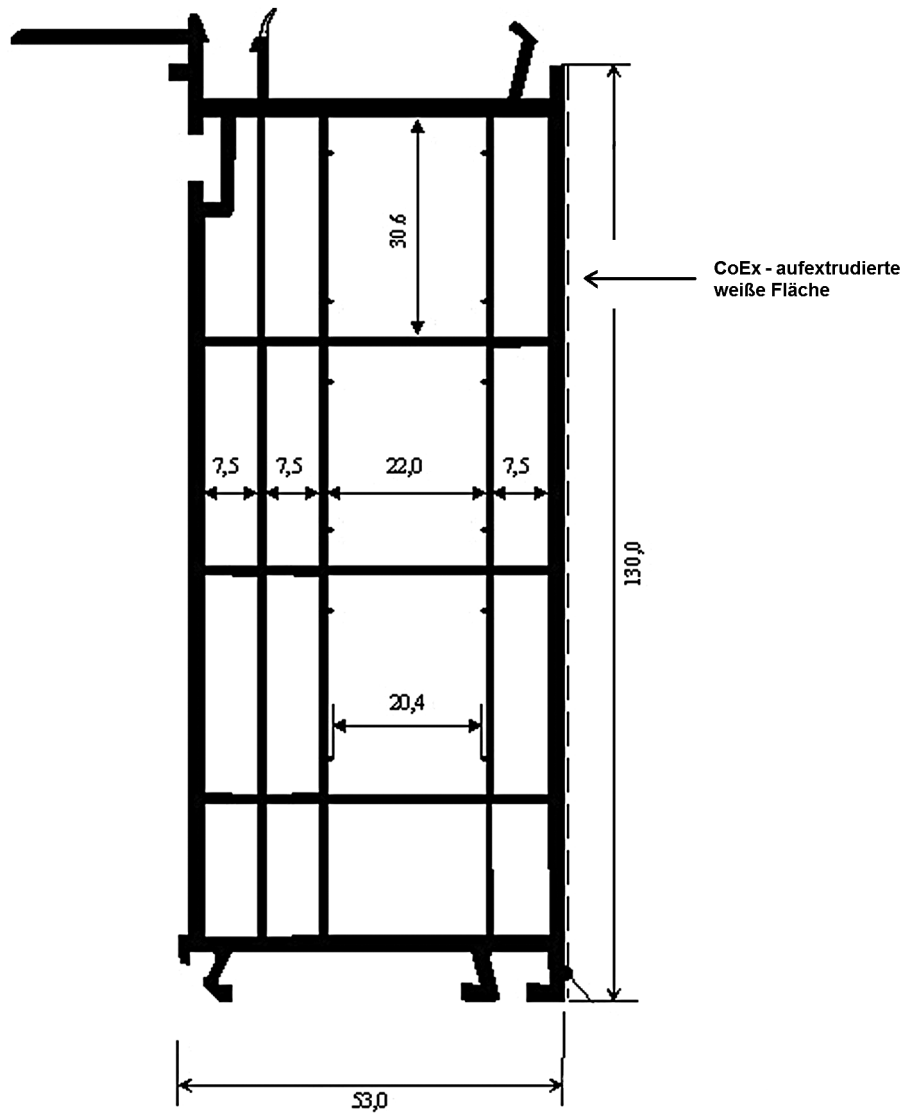











Bottom insert profile



720 / 723 / 725 / 727 / 728 / 722 / 724

Bodeneinstandsprofil

Bottom insert profile

| Art.-Nr. Cat.-No. | Bodeneinstandsprofil Bottom insert profile | Packung / lfm. Package / mtr. | Ausführung Execution | Lieferung Delivery |
|----------------------|---|----------------------------------|--|--|
| 720 | Veka 82er | 13 m |  |  |
| 722 | Rehau Synego | 12 m |  |  |
| 723 | Schüco SI 82 | 12 m |  |  |
| 724 | Schüco Living | 12 m |  |  |
| 725 | Aluplast 70er | 12 m |  |  |
| 727 | Aluplast 85er | 12 m |  |  |
| 728 | Rehau Geneo | 12 m |  |  |

Rahmenverbreiterung und Frame widening and Bodeneinstandsprofil bottom insert profile

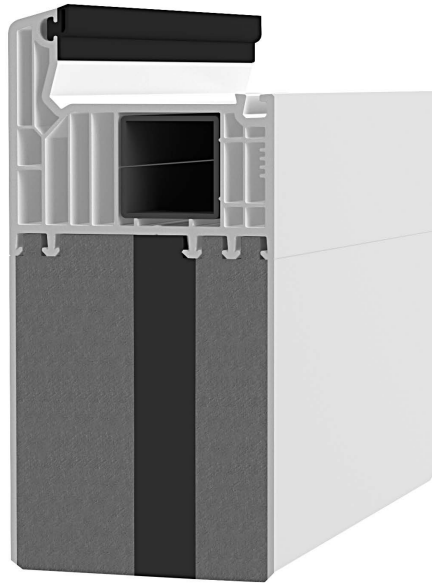

Rahmenverbreiterung und Frame widening and Bodeneinstandsprofil bottom insert profile

| Art.-Nr. Cat.-No. | Bodeneinstandsprofil Bottom insert profile | Packung / lfm. Package / mtr. | Ausführung Execution | Lieferung Delivery |
|----------------------|---|----------------------------------|-------------------------|-----------------------|
| 50504000 | H: 50 mm / T: 50 mm | 4 m | ○ | ☎ |
| 50604000 | H: 50 mm / T: 60 mm | 4 m | ○ | ☎ |
| 50704000 | H: 50 mm / T: 70 mm | 4 m | ○ | ☎ |
| 100504000 | H: 100 mm / T: 50 mm | 4 m | ○ | ☎ |
| 100604000 | H: 100 mm / T: 60 mm | 4 m | ○ | ☎ |
| 100704000 | H: 100 mm / T: 70 mm | 4 m | ○ | ☎ |
| 150504000 | H: 150 mm / T: 50 mm | 4 m | ○ | ☎ |
| 150604000 | H: 150 mm / T: 60 mm | 4 m | ○ | ☎ |
| 150704000 | H: 150 mm / T: 70 mm | 4 m | ○ | ☎ |
| 200504000 | H: 200 mm / T: 50 mm | 4 m | ○ | ☎ |
| 200604000 | H: 200 mm / T: 60 mm | 4 m | ○ | ☎ |
| 200704000 | H: 200 mm / T: 70 mm | 4 m | ○ | ☎ |

- H = Profilhöhe / T = Profiltiefe
- Lieferlänge 4000 mm
- Deckschicht: 2,0 mm weiß, Kern 19 mm PE-Hartschaum
- weitere Abmessungen auf Anfrage

- H = profile height / T = profile depth
- Delivery length 4000 mm
- Top layer: 2.0 mm white, core 19 mm PE rigid foam
- other dimensions available on request

Bodeneinstandsprofil

Bottom insert profile

Anwendungsbeispiel

Example

